

# Seismic Bracketing Assembly Guide

Both **Mamava Original and XL pods** have a Seismic Bracketing Kit that anchors the pod to the floor to meet building safety requirements. If your facility requires seismic bracketing, here is an overview of what you need to do to prepare your site prior to pod installation.

- 1 Seismic Bracketing Kit ships separately in advance of the pod.** If you ordered a pod with a Seismic Bracketing Kit, the kit will ship to you in advance of your pod's arrival. In the box, you will receive components for part one of the seismic bracketing system installation—which you will need to complete prior to the pod assembly—and part two, which occurs as part of the pod installation. Please hold onto all parts and assembly instructions until pod assembly is complete.
- 2 Complete part 1: Drill anchor holes, install anchors, and fasten strut channels to the floor.** Once the Seismic Bracketing Kit and instructions arrive, you are responsible for drilling the anchor holes in the concrete floor where the pod will be placed, installing anchors, and fastening the strut channels to the floor. Pod assembly cannot occur until this step is complete. It should take 1 person approximately 1 hour to complete part 1.
- 3 Schedule pod installation and anchoring.** Once you've completed part 1, Mamava's professional installers will contact you to schedule a time to assemble your pod and complete part 2 of the seismic bracketing system installation, ensuring the pod is properly anchored to the floor. Please ensure you hold onto part 2 components and assembly instructions and have them available for the installers.

# Tools, Parts + Hardware

## Not included



Impact drill with 1/2" masonry drill bit



Sharpie



Tape measure



Eye protection



Hammer



3/8" drive torque wrench



Painters tape

## Provided | PART 1

Complete prior to pod assembly



3/8" drive, deep  
3/4" hex socket



Drill template

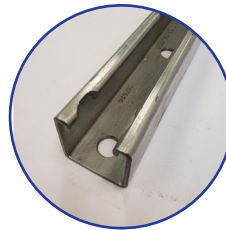

(2) Strut channels



(8) Hilti concrete  
anchors

(includes washer,  
hex nut)

## Provided | PART 2

After pod base is installed  
(Completed by Mamava's professional installers)



(16) Sheet metal screws



3/8" drive, 3/4" crowfoot wrench + wrench extension

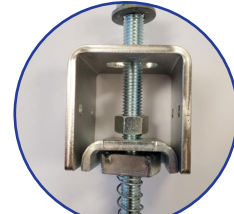

(4) Seismic brackets

(includes channel nut, wolf  
washer, hex nut, flat washer,  
cap screw)

# Drill + Install Hilti Concrete Anchors

## TOOLS AND PARTS

- Drill template
- (2) Strut channels
- (8) Hilti concrete anchor
- Sharpie
- Painters tape
- Impact drill with 1/2" masonry drill bit
- Hammer
- Tape measure

1. Assemble the drill template by snapping together the (4) pieces (labeled XL/Original) for a Mamava Original pod or all (6) pieces for a Mamava XL pod (4 labeled XL/Original, 2 labeled XL).

### ORIGINAL POD TEMPLATE

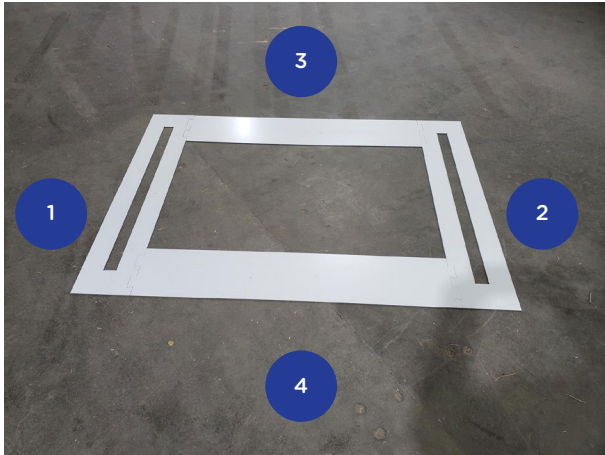

### XL POD TEMPLATE

\*Only use pieces #5 and #6 for XL pods

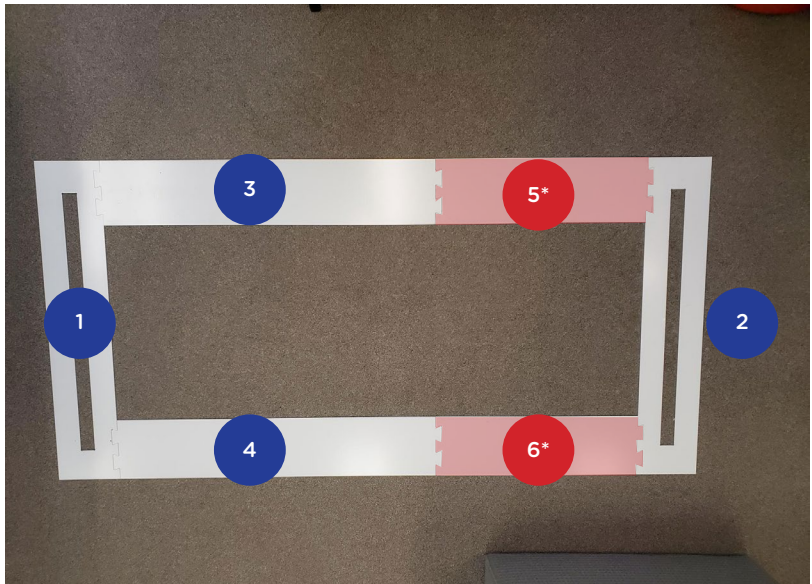

2. The seismic bracketing system requires drilling into a concrete floor.

Place the drill template in the center of the desired pod location place on placement recommendations in Site Preparation. **Important:** The exterior of the pod will extend 13" from the front and back of the template and 17" to the left and right of the template. In addition, you will need a 2' clearance on all sides of the pod exterior for the assembly process and any future service needs. Ensure there are no obstructions within 37" from the front and back of the template and 41" to the left and right of the template.

The power cord comes out of the center back of the pod, just above the floor. Be sure Original pods are placed within 5'7" of a standard outlet and XL pods are placed within 6'7".

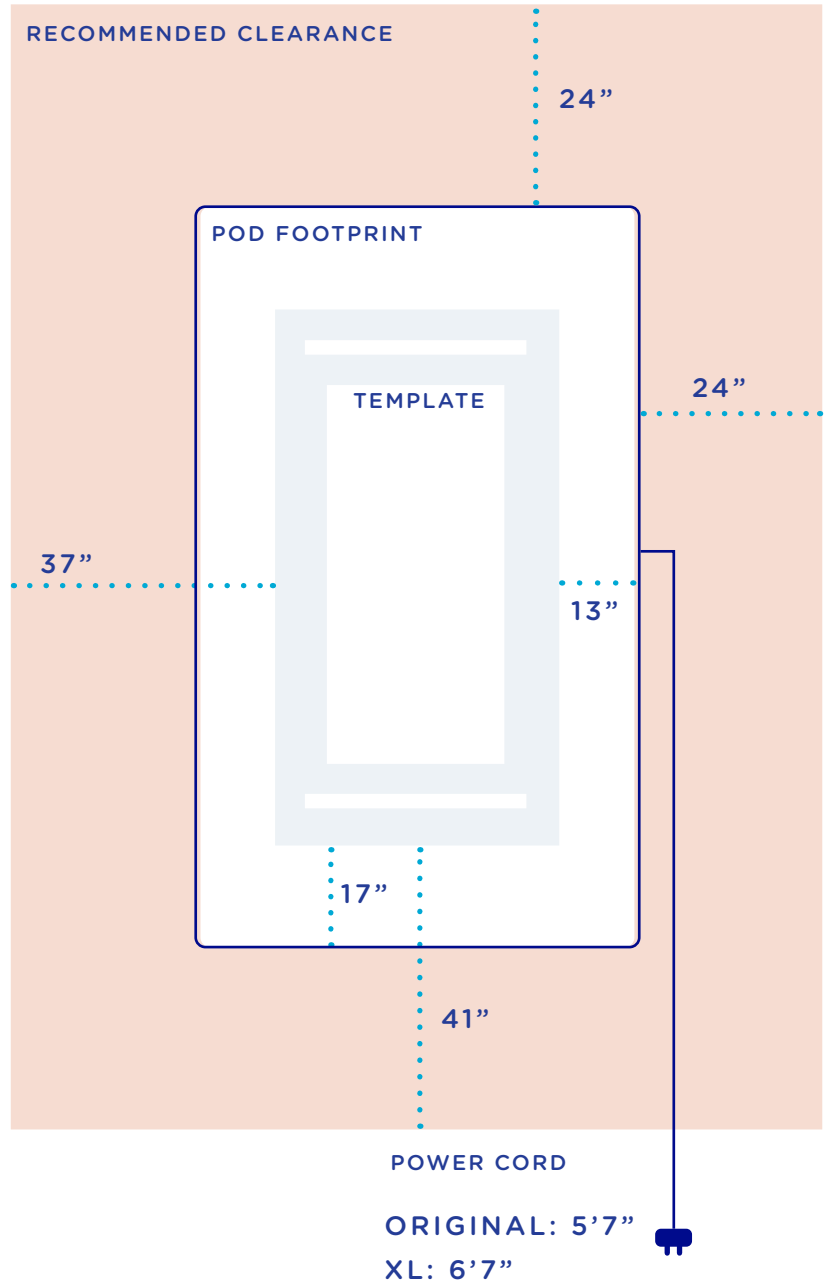

**3.** Place a strut channel into each of the slots located on the ends of the drill template.



**4.** Use a sharpie to mark the (8) strut anchor hole locations on the floor. Each strut channel is unique, so do not swap positions of the strut channels after marking.

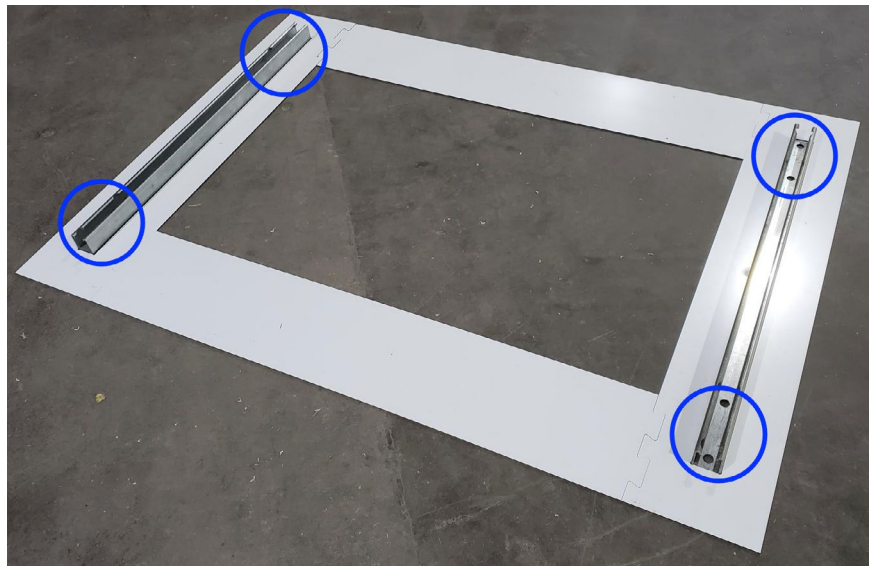

**5.** Remove the drill template and strut channels. The (8) strut anchor hole locations should be visible on the floor.



**6.** Apply a piece of painters tape 2 5/8" from the tip of the drill bit.

Use an impact drill with a 1/2" masonry bit to drill anchor holes into each of the (8) locations marked on the floor. Stop drilling once the tape on the drill bit makes contact with the floor.



Ensure the drill bit stays vertical throughout drilling.

**7.** Use your hammer to insert each of the (8) Hilti concrete anchors into the pre-drilled anchor holes in the concrete floor. Be sure to make contact with the threaded end of the screw and NOT the nut. Stop hammering when the Hilti concrete anchor comes to rest.

The Hilti concrete anchors are a single-use part. If you need to relocate any anchors email [service@mamava.com](mailto:service@mamava.com) for new parts.

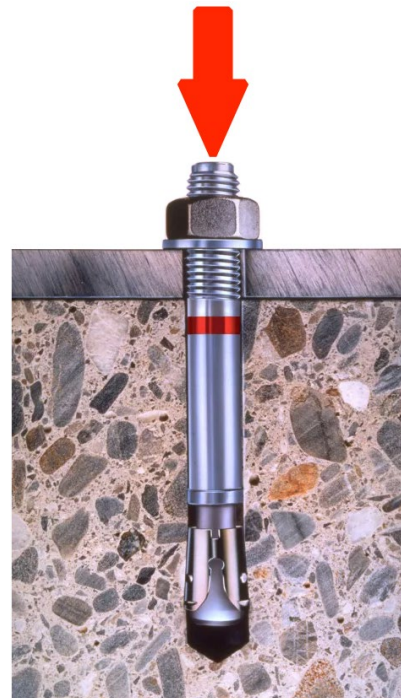

# Fasten Strut Channels to Floor

PART 1

## TOOLS AND PARTS

- (2) Strut channels
- 3/4" socket
- 3/8" drive torque wrench

**1.** Align the holes in the strut channels with the Hilti anchors in the concrete floor and drop into place. Use the same orientation as when you marked the holes.

**2.** Use the 3/4" socket on a torque wrench (with torque set to 25 ft/lb) to tighten the (8) Hilti nuts and secure the anchor in place.

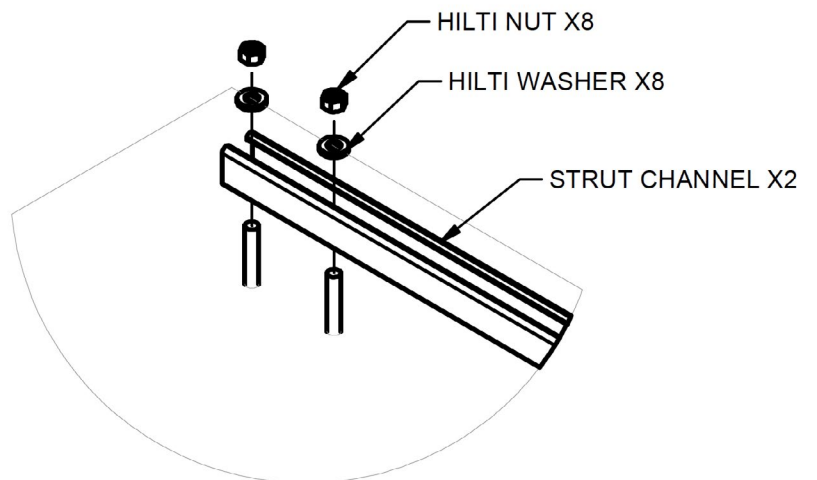
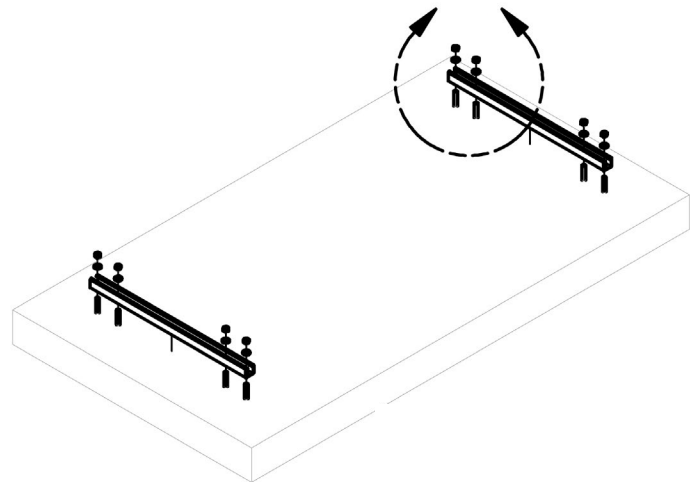
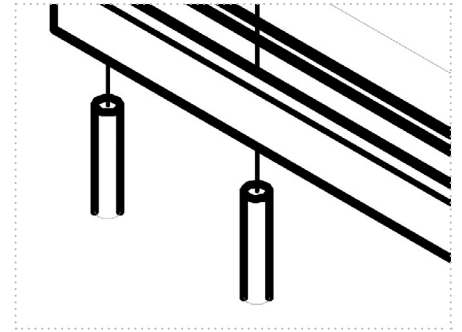
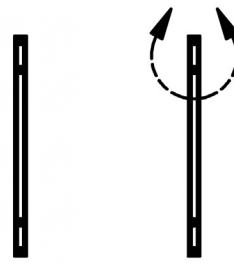

## STOP

Once you've drilled the holes and installed the anchors and strut channels, Mamava's certified professional installers will contact you to schedule a time to complete the pod installation onto the bracketing system and ensure it's properly anchored.

Your work is done!

Please store the part 2 components and assembly instructions and have them available for the installers. We also recommend placing the drill template back on the floor and blocking off the area for safety until the pod assembly is complete.





# Assemble Floor Pan + Pod Chassis

PART 2

## TOOLS AND PARTS

- Floor pans
- Chassis
- (6 - Original, 8 - XL) M8 X 1.25 X 16 mm screws
- XL or Original Assembly Guide
- Phillips head screwdriver
- Adjustable wrench

**1.** Locate the floor pans, pod chassis, M8 x 1.25 X 16 mm screws, and Assembly Guide from your crate shipment.

**2.** Use a Phillips head screwdriver and an adjustable wrench to remove the (4) M6 flathead screws, lock washers, and nuts securing each of the (4) caster wheels to the chassis.

The caster wheels are no longer needed and can be discarded.

**3. Refer to the Floor Pan section in the XL/Original Assembly Instructions and complete Steps 1 and 2, placing the chassis over the respective strut channels on the floor.** Once the floor pan is in place, complete the following steps.

**4.** Locate the leveling feet (bolts marked in red) inside the chassis. There are (4) leveling feet on each side, (2) in the channel closest to you and (2) right behind them.

**5.** Lower each leveling foot by hand until you feel them touch the floor. You'll know they've hit the floor when you can't turn them anymore. Check that all leveling feet are in contact with the floor.



# Anchor Floor Pan + Chassis to Strut Channels

## TOOLS AND PARTS

- (16) Sheet metal screw
- (4) Seismic brackets (includes channel nut, wolf washer, hex nut, flat washer, cap screw)
- Phillips head screwdriver

**1.** Locate the (4) sets of pilot holes on chassis (2 sets per chassis).



**2.** Back the (4) channel nuts off the (4) cap screws until the bottom of the nut and screw sits flush.



**3.** Place the (4) bracket/cap screw/channel nut assemblies onto the chassis. Align the holes in the bracket with the pilot holes in the chassis from Step 1.

**4.** Push down on the (4) cap screws and rotate clockwise until the (4) channel nuts catch in the strut channel, then release.

**5.** Use a Phillips head screwdriver to fasten the (4) seismic bracket assemblies onto the left and right chassis using the (16) sheet metal screws (4 screws per seismic bracket).

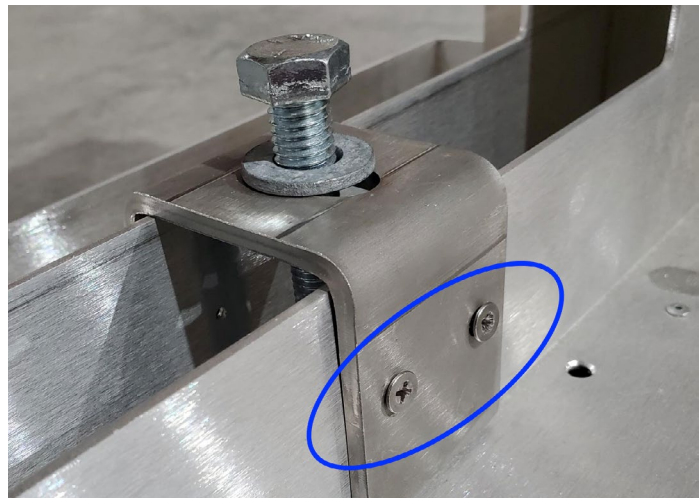

**6.** Ensure the (4) wolf washers are properly seated on the (2) strut channels.



# Pod Assembly + Final Seismic Anchoring

PART 2

## TOOLS AND PARTS

- XL/Original Assembly Instructions
- XL/Original pod assembly components
- Hex key
- 3/8" torque wrench
- 3/4" socket
- 3/4" crowfoot wrench
- Wrench extension

**1.** It's time to complete the pod assembly. Refer to the XL or Original Assembly Instructions. Ensure that the door is properly aligned without any gaps between the top of the door and the header. Then come back to complete the remaining steps.

**2.** Open the pod using either 8008 on the keypad or your key. Remove the adhesive covers on the two beauty panels and stick them next to the rotolock holes for now.

**3.** Use an hex key to unlock the rotolocks. The right hole unlocks with a counterclockwise rotation, and the left hole unlocks with a clockwise rotation.

**4.** Carefully pull the beauty panels out, starting with the top flange then unhook from the bottom.

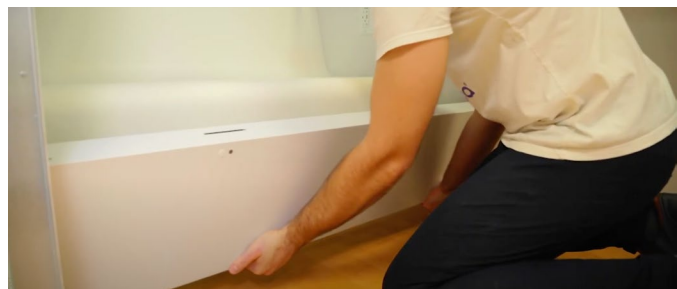
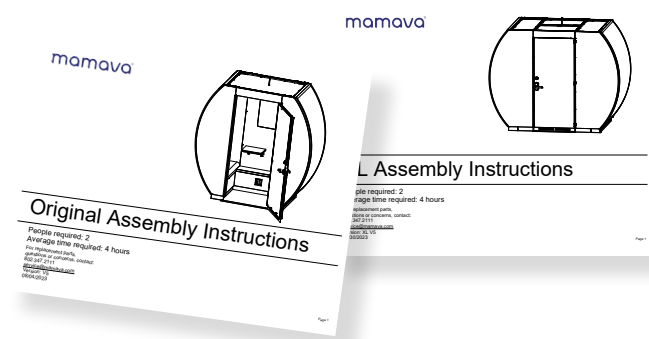

**5.** Use the 3/4" socket to tighten the (4) cap screws onto the (4) seismic brackets.

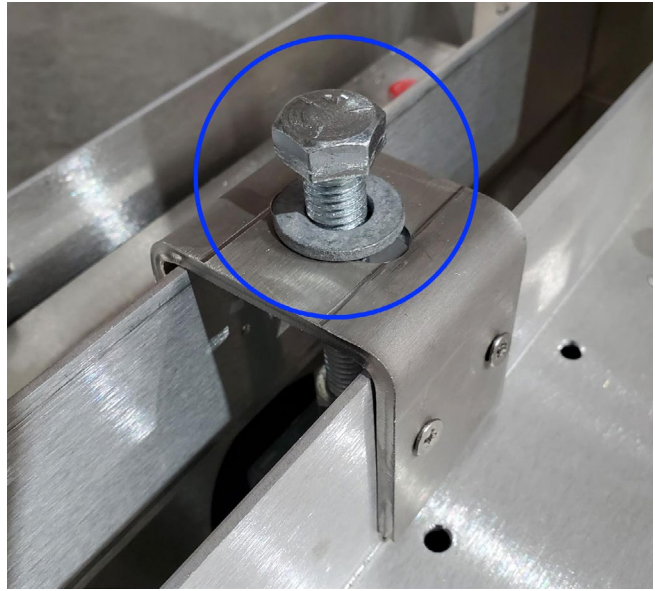

**6.** Use the 3/4" crowfoot wrench and wrench extension to tighten down the (4) hex nuts and secure the pod chassis to the strut channels. Test that the pod chassis is securely affixed to the channel.

**ASSEMBLY IS COMPLETE!**

